

Materiale Testata : Acciaio INOX AISI 316L

Head Material : SS AISI 316L

RPM	CODICE CODE	MODELLO MODEL	PORTATA FLOW		PRESSIONE PRESSURE		POTENZA POWER		PESO WEIGHT	
			l/min	GPM	bar	PSI	HP	kW		
1450	620200	CSC 42/17 S	44.0	11.6	170	2465	19.2	14.3	19.7	S - Albero MASCHIO 24 mm DX
	620300	CSC 50/15 S	50.0	13.2	150	2175	19.2	14.3	19.7	S - MALE Shaft 24 mm RIGHT

- **Minimo 0.1 bar (1.45 PSI) di Pressione in Entrata / Min. 0.1 bar (1.45 PSI) Inlet Pressure**

Tutti i modelli di Pompe sono disponibili con Presa di Forza Sinistra. Nel Modello compare "-L". Esempio : CSC 42/15 S-L

All models of PUMPS are available with Left P.T.O. Shaft. Descriptions mention "-L". For example : CSC 42/15 S-L

Dimensioni d'ingombro (mm) - Overall Dimensions (mm)

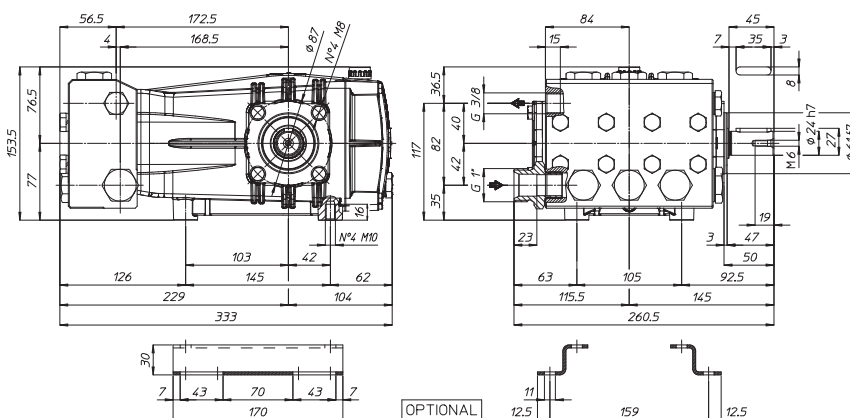

620300 - PUMP CSC 50/15 S

