

C

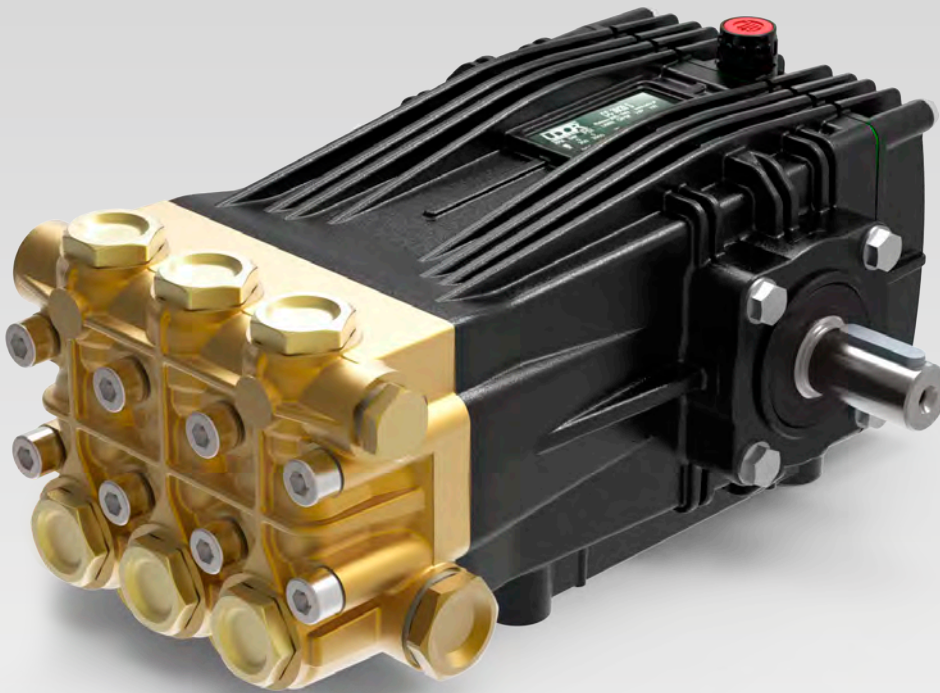

Tutti i modelli di Pompe della Serie C sono disponibili con certificazione Atex, su richiesta.

Upon request, all models of C pumps series are available with ATEX certification"



RPM	CODICE CODE	MODELLO MODEL	PORTATA FLOW		PRESSIONE PRESSURE		POTENZA POWER		PESO WEIGHT	PRESA DI FORZA SHAFT TYPE
			l/min	GPM	bar	PSI	HP	kW		
1000	900100	CB 21/20 S	21.0	5.5	200	2900	10.8	8.1	15.8	S - Albero MASCHIO 24 mm DX S - MALE Shaft 24 mm RIGHT
	901200	CC 21/20 S	21.0	5.5	200	2900	10.8	8.1	15.8	
1450	901500	CC 26/20 S	26.0	6.9	200	2900	13.3	9.9	15.8	
	900000	CC 30/20 S	30.0	7.9	200	2900	15.4	11.5	15.8	
	900800	CC 34/20 S	34.0	9.0	200	2900	17.4	13.0	15.8	
1750	902100	CD 5.5/30 S	20.8	5.5	200	2900	10.7	8.0	15.8	
	901300	CD 7.0/30 S	26.5	7.0	200	2900	13.6	10.1	15.8	
	902200	CD 7.5/30 S	28.0	7.4	200	2900	14.4	10.7	15.8	
	901700	CD 8.5/30 S	32.2	8.5	200	2900	16.5	12.3	15.8	

Tutti i modelli di Pompe sono disponibili con Presa di Forza Sinistra. Nel Modello compare "-L". Esempio : CB 21/20 S-L

All models of PUMPS are available with Left P.T.O. Shaft. Descriptions mention "-L". For example : CB 21/20 S-L

Dimensioni d'ingombro (mm) - Overall Dimensions (mm)

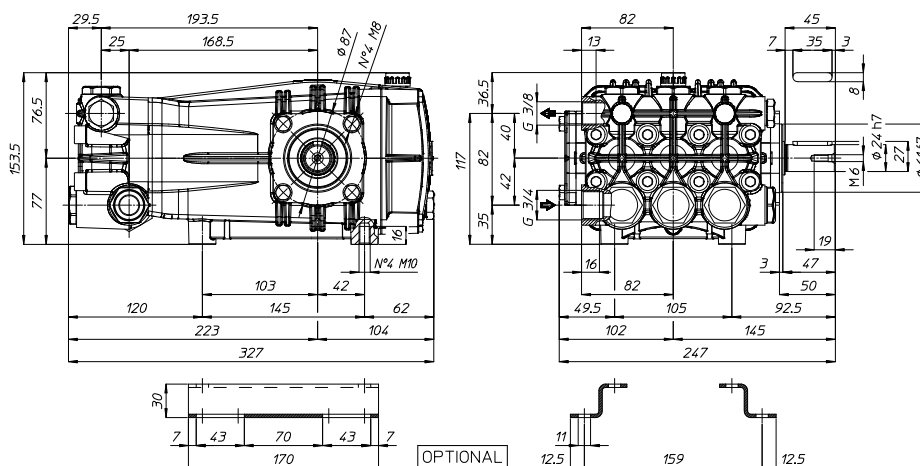

900000 - PUMP CC 30/20 S

